

Digi - SENSE®

Platinum RTD Thermometer

MODEL NO. 60010-80

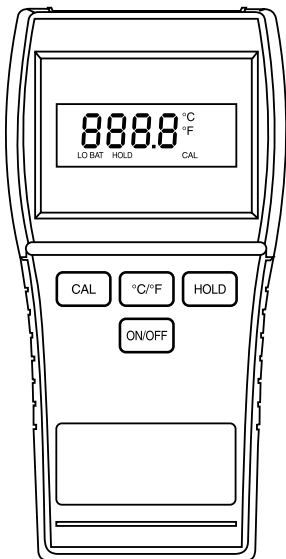

Digi - SENSE®

Eutech Instruments Pte Ltd

Blk 55 Ayer Rajah Crescent
#04-16 Singapore 139949

Tel: (65) 6778 6876

Fax: (65) 6773 0836

Website: www.eutechinst.com
email: marketing@eutechinst.com

68X309903 Rev.1.1 02/03

ISO 9001
REGISTERED

CERTIFICATE OF CONFORMANCE

This thermometer was calibrated using equipment traceable to the National Institute of Standards and Technology (NIST).

This instrument conforms to
DIN IEC 751 revised to ITS-90.



The accuracy of the thermometer at the time of calibration was within specifications stated in the operating manual.

Model No.: _____

Serial Number: _____

Date placed in service: _____

To purchase an NIST certificate of traceability with test data and test date for meter and probe please contact your dealer or:

Barnant Company
28W092 Commercial Avenue
Barrington, Illinois USA 60010-2392

Toll-free: 800-637-3739

ISO 9001
REGISTERED

INTRODUCTION

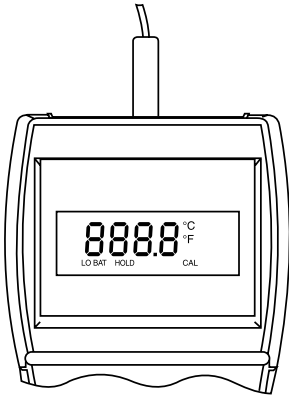



This versatile hand-held instrument provides highly accurate temperature measurements. The instrument is designed for easy operation and includes the following features:

- Operator selection of Celsius or Fahrenheit scale
- Resolution of 0.1° (auto ranging)
- Four-digit LCD
- Hold feature for temporarily retaining a reading
- Field calibration capability
- Low battery warning
- Built-in tilt stand for easy hands-free operation
- 3-pin circular connector input
- Operates with a wide selection of probes

SAFETY PRECAUTIONS

 **DANGER** *VOLTAGES PRESENT AT THE RTD MAY ALSO BE PRESENT AT THE BATTERY TERMINALS. ALWAYS DISCONNECT THE RTD WHEN CHANGING BATTERIES.*

 **WARNING** *THIS INSTRUMENT IS DESIGNED TO ACCEPT LOW LEVEL SIGNALS SUPPLIED BY STANDARD 100 OHM PLATINUM RTDS. UNDER NO CIRCUMSTANCES SHOULD THE INPUT VOLTAGE EXCEED THE SPECIFIED 10 V RMS.*

 **CAUTION** *DO NOT USE OR STORE THIS INSTRUMENT IN MICROWAVE OVENS OR ANY ABNORMALLY HOT OR COLD AREAS.*

 **CAUTION** *WEAK BATTERIES SHOULD NOT BE LEFT IN THE INSTRUMENT. DEAD BATTERIES CAN LEAK AND CAUSE DAMAGE TO UNIT.*

SPECIFICATIONS

PLATINUM RTD PROBES

100 ohm platinum: alpha = 0.003850

-200 °C to 850 °C (-392 °F to 1562 °F)

Out of range display: “Ur”, “Or”, “oPEn”

Accuracy and Resolution:

Range	Accuracy	Resolution
-200 to -100 °C (-392 to -148 °F)	±2 °C (±4 °F)	1°
-100 to 200 °C (-148 to 392 °F)	±0.2 °C (±0.4 °F)	0.1°
200 to 850 °C (392 to 1562 °F)	±2 °C (±4 °F)	1°

Display: 4-digit LCD with 0.4 inch (10 mm) high numerals.

Display update rate: 0.5 sec per update.

Input: One probe with 3-pin circular connector (Switchcraft TA3F).

Input Protection: 10V rms

Battery: Two AA, 1.5V alkaline ANSI-L40, IEC-LR6.

Battery Life: 200 hours continuous, typical.

Low battery indication: Battery symbol on when 8 to 10 hours of battery life remains.

Auto Shutoff: 17 minutes after last key press.

Operating:

Stated accuracy: 18°C to 28°C (64°F to 82°F)

Useful range: 0°C to 40°C (32°F to 104°F)

Storage: -40°C to 65°C
(-40°F to 149°F)

Humidity: 10% to 90%
(non-condensing)

Dimensions

3 cm D x 8.4 cm W x 15.8 cm H
(1.2 in x 3.3 in x 6.2 in)

Weight with batteries: 227 grams (8 ounces)

Ingress protection: Meets IEC-529 IP-54 for dust-
and water-resistant enclosures.

Compliance (For CE Mark): EN61326-1/A1: 1998
(EU EMC Directive)

BATTERY INSTALLATION AND REPLACEMENT

 **DANGER** *VOLTAGES PRESENT AT THE RTD MAY ALSO BE PRESENT AT THE BATTERY TERMINALS. ALWAYS DISCONNECT THE RTD WHEN CHANGING BATTERIES.*

 **CAUTION** *WEAK BATTERIES SHOULD NOT BE LEFT IN THE INSTRUMENT. DEAD BATTERIES CAN LEAK AND CAUSE DAMAGE TO UNIT.*

If battery indicator turns on, battery life is approximately 8 to 10 hours.

See **SPECIFICATIONS** for battery type.

1. Before changing battery, turn instrument off and disconnect probe.
2. Loosen screw and lift battery cover off back of case.
3. Remove the two AA batteries.
4. Insert two new batteries, observing polarity.
5. Install cover and tighten screw.

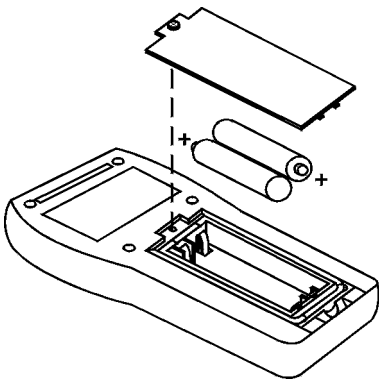

CONNECTING AN RTD

Use the correct 100 ohm RTD ($\alpha = 0.003850$) for your instrument. Using an incorrect probe type will result in erroneous readings. Insert the 3-pin plug into the mating connector on the top of the instrument.

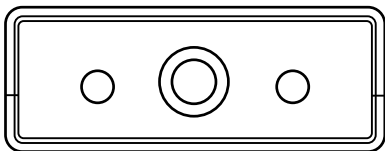

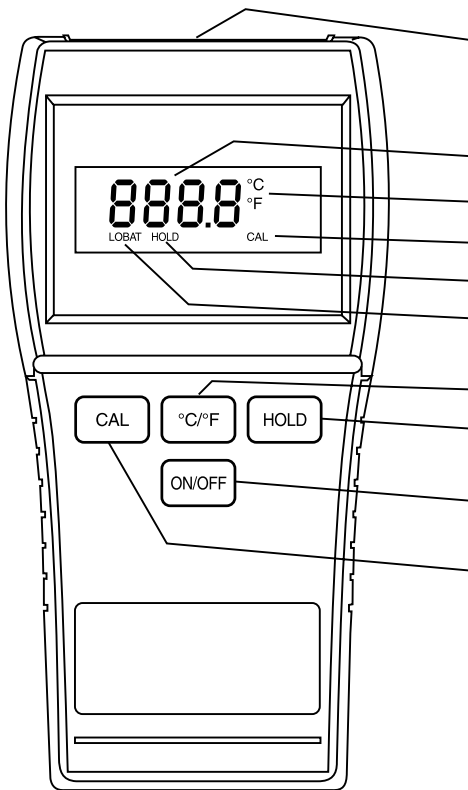

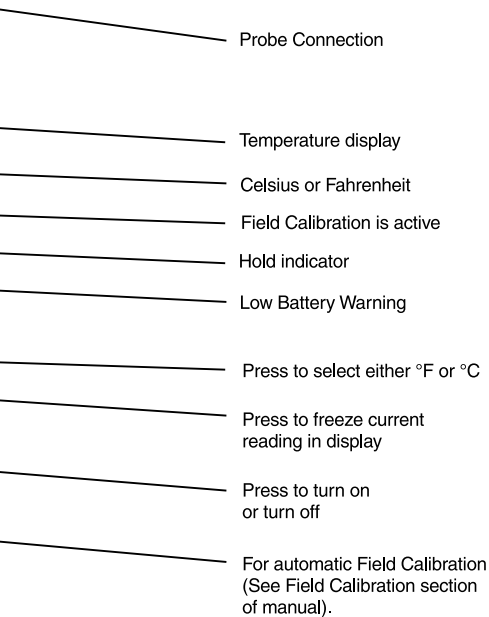

OPERATION

1. Press the **ON/OFF** key. The thermometer performs a self-test and all display digits and indicators, as shown below, should remain on for approximately two seconds.



2. If a probe is not connected or if the probe is defective, the display will indicate "oPEn".
3. Select °C or °F by pressing the **°C/°F** key. Temperature scale can be switched at any time. The thermometer retains the last selected scale the next time you turn the power on.
4. For optimum instrument accuracy, allow one minute for ambient temperature stabilization. If the unit has been stored at an extreme ambient condition, more time will be needed.

When taking temperature measurements, allow time for the reading to stabilize. Multiplying the time constant of the probe by 5 will give you the approximate time required.

If desired, press the **HOLD** key to retain the reading on the display. Press **HOLD** key again for normal operation.

The display will show "Ur" (under range) or "Or" (over range) if the temperature reading is out of range of the instrument.

FIELD CALIBRATION

The thermometer is factory calibrated and does not require calibration before use. The CAL function allows single point calibration of the thermometer at 0°C (32°F) to compensate for probe offset error. It is not necessary to perform a field calibration to obtain specified meter accuracy. Use the field calibration feature to improve thermometer/probe accuracy.

1. Follow steps 1 through 4 in **FIELD CALIBRATION CLEAR/UNLOCK** section.
2. Pack sensing end of probe in a container tightly packed with crushed ice and filled with distilled water. Allow temperature to stabilize.
3. Press and release the **CAL** key to enter the calibration mode.
4. The display will momentarily show “CA” and then the temperature reading starts blinking.
5. If the measured temperature is from –5°C to 5°C (23 to 41°F) when the temperature reading is stable, press the **HOLD** key to confirm calibration.

The display will momentarily show “CO” and the reading will be set to 0°C (32°F). The CAL indicator will turn on, indicating a field calibration is active. *The field calibration is automatically locked as well.*

If “Err” is displayed, either the displayed reading is outside the above limits or the batteries are weak.

FIELD CALIBRATION CLEAR/UNLOCK

The calibration clear/unlock feature will cancel any previous field calibration (the thermometer reverts to the default factory calibration) and also enables the field calibration operation.

1. Turn the thermometer off.
2. Hold the **CAL** key down while pressing the **ON/OFF** key.
3. Unit will first display 8888 then the firmware version number.
4. When the **CAL** key is released, the unit will return to measurement mode.

FIELD CALIBRATION LOCKOUT

The calibration lockout feature prevents any field calibration changes. The lockout remains in effect until a clear/enable has been performed. Use the following procedures to lockout the field calibration operation.

Lockout Procedure

1. Turn the thermometer off.
2. Hold the **HOLD** key down while pressing the **ON/OFF** key.
3. Unit will first display 8888 then the firmware version number.
4. When the **HOLD** key is released, the unit will display 8888 and then turn off. (If field calibration is already locked, the unit will return to measurement mode.)

MAINTENANCE

Properly used, the thermometer should maintain calibration indefinitely and not require service other than occasional cleaning of the housing and changing of the batteries.

Do not clean with abrasives or solvents. Use mild detergents; never immerse nor use excessive fluid.

BATTERIES

If there is no display when the thermometer is turned on, check condition of the two AA batteries. Also check that the battery terminals are clean and batteries are properly installed. If replacement is necessary, refer to the **BATTERY INSTALLATION AND REPLACEMENT** section for replacement procedure.

SERVICE

There are no internal adjustments or user-replaceable parts.

Note: Serial number label is located inside battery compartment.

EU Declaration of Conformity

Name of Apparatus: Platinum RTD Thermometer

Model Number: 60010-80

Description of Apparatus: Electronic thermometer
using a platinum RTD probe

Barnant Company declares that the above model is in conformity to the following harmonized standards and directives:

Applicable Directives	Applicable Specifications	Manufacturer's Report Number
89/336/EEC 92/31/EEC 93/68/EEC	EN61326-1/A1: 1998	TR0180

Manufacturer:

Barnant Company Division
Cole-Parmer Instrument Company
28W092 Commercial Avenue
Barrington, IL 60010-2392
USA
Tel.: 847-381-7050

Manufacturer's Signature:

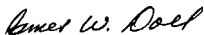

James W. Doll
Vice President, Engineering

20 August, 2001

Date

ACCESSORY RTD PROBES

Eutech Instruments offers a wide variety of RTD probes, connectors, extension cables, accessories and calibration services.

The popular probes listed below have a nylon handle, a 5-ft coiled cord and a 316 SS sheath.

General-purpose probe, 10 in long x 0.188 in dia. 10 second time constant.

08117-70

PTFE-coated general-purpose probe, 10 in long x 0.145 in dia. 15 second time constant.

08117-87

Penetration probe, 4 in long x 0.188 in dia sharp tip. 10 second time constant.

08117-85

Surface probe, 8 in long with 0.25 in dia aluminum and ceramic tip. 24 second time constant.

08117-75

Air/gas probe, 10 in long sheath with 0.25 in dia radiant heat shield. 4 second time constant.

08117-90

611-0090 Soft carrying case.

WARRANTY

The Manufacturer warrants this product to be free from significant deviations from published specifications. If repair or adjustment is necessary within the warranty period, the problem will be corrected at no charge if it is not due to misuse or abuse on your part as determined by the Manufacturer. Repair costs outside the warranty period, or those resulting from product misuse or abuse, may be invoiced to you.

The warranty period for this product is noted on the Warranty Card.

PRODUCT RETURN

To limit charges and delays, contact the seller or Manufacturer for authorization and shipping instructions before returning the product, either within or outside of the warranty period. When returning the product, please state the reason for the return. For your protection, pack the product carefully and insure it against possible damage or loss. Any damages resulting from improper packaging are your responsibility.

TECHNICAL ASSISTANCE

If you have any questions about the use of this product, contact the Manufacturer or authorized seller.

Trademarks bearing the ® symbol in this publication are registered in the U.S. and in other countries.